



DMC Co., Ltd.

**Mutli-touch Resistive (MTR) Controller
MTR2010 Product Specification**

Table of Contents

1. Product Overview.....2

 1.1. Applicable Product.....2

 1.2. Overview.....2

 1.3. Touch Detection Principle2

 1.4. Cases that the controller does not recognize the correct coordinate points.....3

2. Specifications.....4

 2.1. General Specification.....4

 2.2. Performance Specification4

 2.3.Product ID.....4

 2.4. Minimum Distance between Fingers5

 2.5. Electrical Specification.....6

 2.5.1. Maximum Absolute Rating.....6

 2.5.2. DC Characteristics6

3. Connector.....7

 3.1. Connector Terminal7

 3.2. Mounted Connector7

4. Warranty.....8

 4.1. Warranty Period.....8

 4.2. Warranty Target.....8

 4.3. Warranty Exceptions.....8

5. Handling notes9

 5.1. Overall handling notes9

 5.2. Others.....9

6. Revision History 10

 6.1. Revision History.....10

Outline Dimensional Drawing

1. Product Overview

1.1. Applicable Product

This specification sheet is applied to MTR2010 series, the Multi-touch Resistive controller.

1.2. Overview

MTR2010 series is Multi-touch Resistive (MTR) touch screen controller board that recognizes dual inputs and is suitable for pen writing applications.

1.3. Touch Detection Principle

MTR Touch Screen is composed of matrix CELLS.

Multiple touch inputs are recognized by detecting a touch input in each CELL.

The top left of the active area is (X=0, Y=0), while the bottom right is (X=0x03FF, Y=0x03FF).

Fig1 Touch Detection Range (case of 15x12)

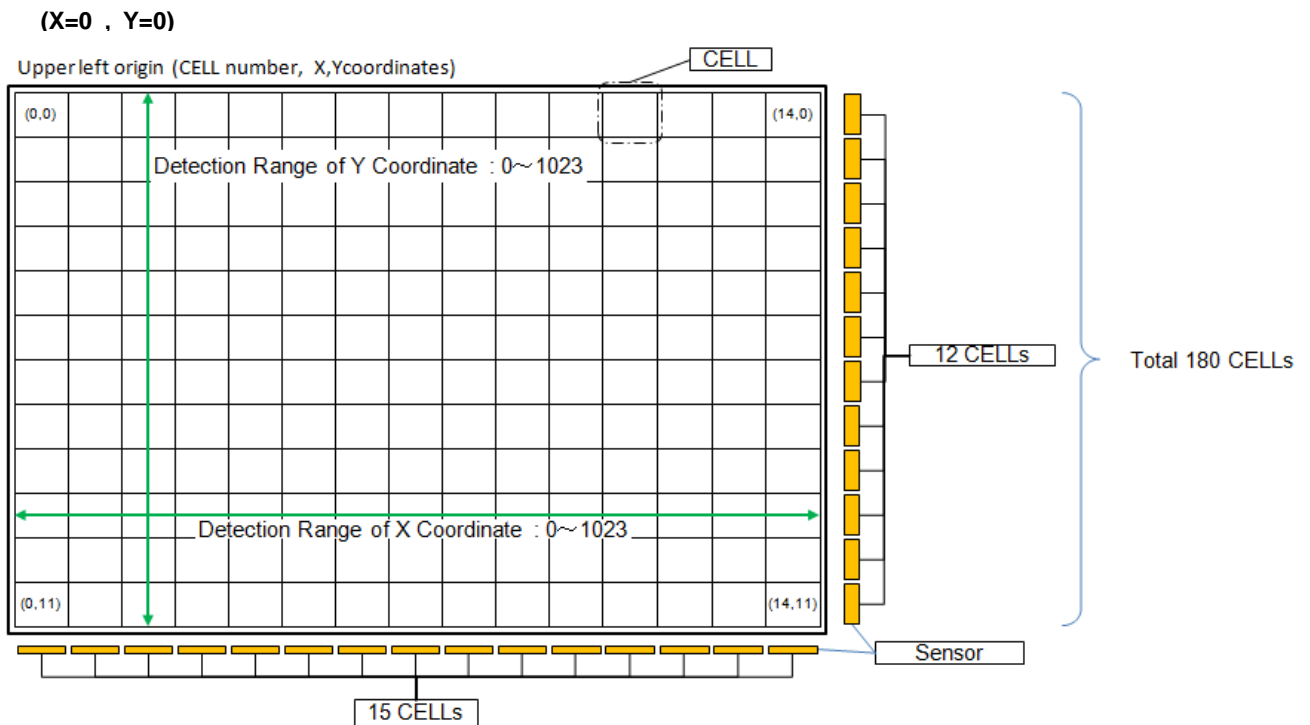

1.4. Cases that the controller does not recognize the correct coordinate points

1. Controller does not recognize dual touch inputs in the same CELL. (Fig 2.)
(In case of multiple touch inputs in the same CELL, middle point will be outputted.)

Fig 2. 2 points in the same matrix CELL

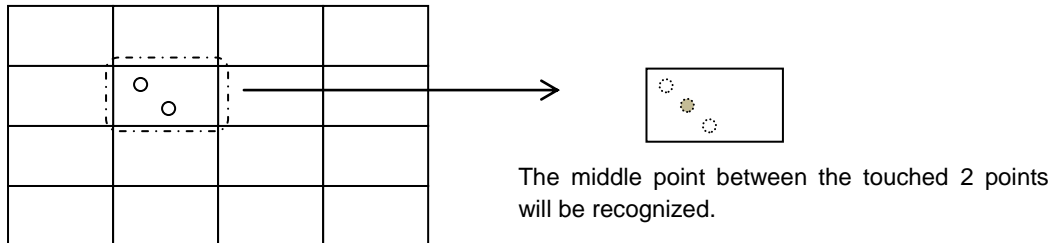

2. 2nd touched point can be affected if 1st touched point is on boundary of a CELL.
Looking at the touch screen as its FPC tail is on the bottom side, when the 1st touched point is on horizontal boundary of a CELL (indicated as yellow circle in Fig3), and the 2nd touched point is either on the top or bottom boundary of the right-side adjacent CELLS (red lines "A" in Fig3), or the top or bottom boundary of 3 CELLS away in right direction (red lines "B" in Fig3), then the 2nd touched point can be unstable. (Either unstable output, or coordinate can be away from actual touched point in inner direction).

Fig3 1st and 2nd touched points on boundaries of CELLS

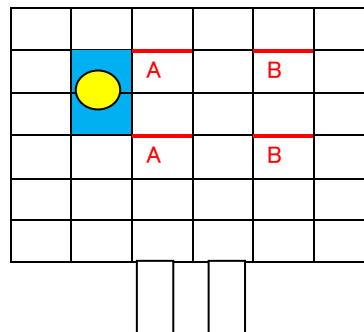

3. 2nd touched point can be affected if 1st touched point is on an intersection of CELLS.
If the 1st touched point is on an intersection of CELLS, then the 2nd touched point is on an intersection of 1 CELL away in X direction and 3 CELLS away in Y direction from the 1st touched point (indicated in Fig4), or intersection of 2 CELLS away in X direction and 1 CELL away in Y direction from the 1st touched point (indicated in Fig5), the 2nd touched point can be unstable. (Either unstable output, or coordinate can be away from actual touched point in inner direction).

Fig4. 2nd touched intersection is 1 CELL in X and 2 CELLS in Y away from 1st touched intersection.

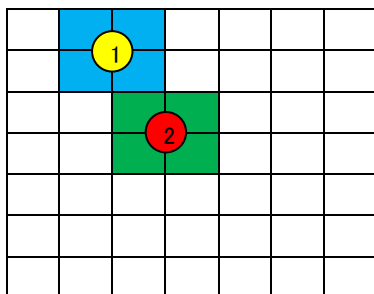
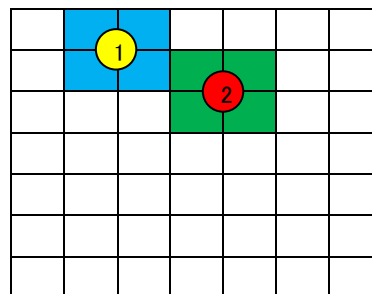

Fig5. 2nd touched intersection is 2 CELLS in X and 1 CELL in Y away from 1st touched intersection.



2. Specifications

2.1. General Specification

Item		Rating	Remark
Operating Temp.		-20°C to +85°C (No condensation)	
Storage Temp		-20°C to +85°C (No condensation)	
Supply Voltage		DC 4.75V to 5.25V	
Consumption Current		45 mA (Typical)	5.0V at dual touch
Communication (USB)	Method	USB2.0 HID1.1	Operated via HID digitizer/HID mouse Protocol
	Rate	Full-speed 12 [Mbps]	
Linearity Error		±2LSB or lower	
External Dimensions		50×35 (mm)	
Max Height of Component		2.95 (mm)	

2.2. Performance Specification

Item		Rating	Remark
Max Multi-touch Points		2 points	
Coordinate Resolution		10bit (1024×1024)	
* Input Response Time		8x7 matrix CELLS 1 point detection: 10ms 2 points detection: 11.8ms	Typical (When used with MTR-G084A070A, 8.4inch standard touch screen)

*The input response times described above are actual values of when 1 finger touches only 1 CELL. If 1 finger touches over several CELLS, the input repose time will be affected.

For reference: 1 finger over 4 CELLS approx 35ms (TYP)
2 fingers over 8 CELLS approx 60ms(TYP)

*Drawing operability may depend on specifications of PC in use.

2.3.Product ID

Item	Rating	Remarks
Vendor ID	0x0AFA	
Product ID	0x03F1	

2.4. Minimum Distance between Fingers

If there are 2 input points detected within the electrode width (within a CELL), MTR will recognize 1 point only. Even if a distance between 2 input points is greater than electrode width, input detection may be affected according to size of the touching finger.

For how to calculate the minimum distance which can detect 2 points, refer to the following

Size of finger → C

Width of Electrode → Xw, Yx

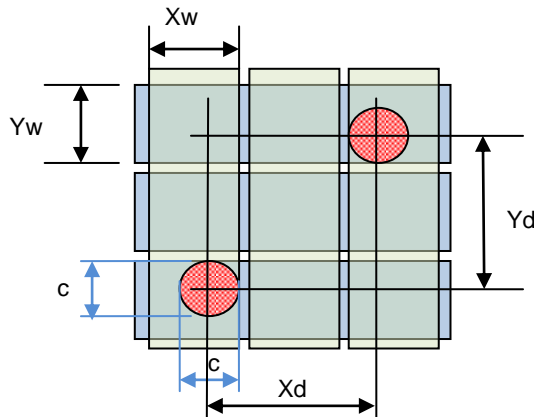

Item	Formula	Remarks
X-axis minimum distance (Xd)	$(Xw * \sqrt{2}) + c$	
Y-axis minimum distance (Yd)	$(Yw * \sqrt{2}) + c$	

If distance between 2 points is shorter than the minimum, detection of X or Y-axis can be 1 point only, or detection can be invalid.

<For Reference>

In case of MTR-084A070B (8.4inch standard touch screen), its electrode width is as follows.

Xw=21.1mm

Yw=18.1mm

Given that size of finger is 5cm, Xd, Yd, and minimum linear distance will be as follows.

Xd ≒ 34.8mm、

Yd ≒ 30.6mm

Minimum linear distance between 2 points ≒ 46.3mm

2.5. Electrical Specification

2.5.1. Maximum Absolute Rating

Item	Specifications			Unit	Note
	Min.	Typ.	Max.		
Touch Panel Power Supply	-0.3		6	V	

2.5.2. DC Characteristics

Board Consumption Current

Test Condition : TA = 25°C, VCC = 5V

Item	Specifications			Unit	Note
	Min.	Typ.	Max.		
Touch Panel Power Supply	4.75	5	5.25	V	
Normal operation mode		45		mA	Scan rate:85Hz 2 Finger, 8.4inch DC5V, USBVBUS
Suspend mode		5		mA	USBVBUS

USB Signal (D+, D-) DC Characteristics

Parameter	Specifications			Unit	Note
	Min.	Typ.	Max.		
Input High Voltage	2.0	-	-	V	
Input Low Voltage	-	-	0.8	V	
Output High Voltage	2.8	-	3.6	V	
Output Low Voltage	0	-	0.3	V	

Parameter	Specifications			Unit	Note
	Min.	Typ.	Max.		
Input High Voltage	2.31	-	-	V	
Input Low Voltage	-	-	0.66	V	
Minimum pulse width	20	-	-	ms	

3. Connector

3.1. Connector Terminal

USB Connector

CN	Terminal No.	Terminal Name	Function
CN1	1	Vbus	USB power input (5V)
	2	D-	USB D-
	3	D+	USB D+
	4	GND	USB Gnd
	5	RESETn	Terminal for rest, Active L
	6	GND	GND for reset

Touch screen connector 1

CN	Function
CN4	Touch screen connector 18pins

Touch screen connector 2

CN	Function
CN5	Touch screen connector 16pins

3.2. Mounted Connector

CN	P/N	Manufacturer
CN1	SM06B-SRSS	J.S.T.MFG.CO.,LTD.
CN4	FH34SRJ-18S-0.5SH	HIROSE ELECTRIC CO., LTD.
CN5	FH34SRJ-16S-0.5SH	HIROSE ELECTRIC CO., LTD.

4. Warranty

4.1. Warranty Period

- § The warranty period is limited to 1 year from the date of shipping. The warranty for the initial deflection such as appearance deflection is limited to 1 month.
- § Any defected parts under proper use will be examined by the supplier and replaced by the new parts if the deflection is considered to be caused by the supplier.
- § The replacement is subject to be included in the next lot.

4.2. Warranty Target

- § The warranty only covers the product itself and does not cover any damage to others caused by using this product. Onsite repair or replacement is not supported.
- § We will do our best for delivery problem and product defections, but the warranty for the production line is not covered.

4.3. Warranty Exceptions

Following conditions are not covered with the warranty and subject to charge.

- § Any malfunctions and damages during transportation and transfer by the user.
- § Any malfunctions and damages caused by a natural disaster or a fire.
- § Any malfunctions and damages caused by static electricity
- § Any malfunctions and damages caused by the failure of the associated equipment.
- § If the product is remodeled, disassembled or repaired by the user.
- § If the product is glued onto the equipment and uninstalled.
- § Any malfunctions and damages caused by an improper usage and handling against the specifications and notes.

5. Handling notes

5.1. Overall handling notes

- § Keep the product away from any conductive objects while in use.
- § Do not touch the conductive part of the product to avoid being damaged by the electrostatic discharge. Follow the proper procedure for handling.
- § Keep the product in the proper storing environment and avoid any load to the product.
- § Do not use or store the product in the severe condition like following:
 - Wet environment or a condition where the product is likely to get wet.
 - Where dew condensation is likely to occur.
 - Near solvent or acid.
- § Do not take apart or alter the product.

5.2. Others

- § The contents of this document are subject to change without notice.
- § The manufacturer or sales representatives will not be liable for any damages or loss arising from use of this product.
- § This product is intended for use in standard applications (computers, office automation, and other office equipment, industrial, communications, and measurement equipment, personal and household devices, etc.) Please avoid using this product for special applications where failure or abnormal operation may directly affect human lives, or cause physical injury or property damage, or where extremely high levels of reliability are required (such as aerospace systems, vehicle operating control, atomic energy controls, medical devices for life support, etc.).
- § Any semiconductor devices have inherently a certain rate of failure. The user must protect against injury, damage, or loss from such failures by incorporating safety design measures into the user's facility and equipment.

6. Revision History

6.1. Revision History

Rev. 1.0 (October 28, 2019)

First Release

MTR2010 Series Product Specification
Rev. 1.0 issued on October 28, 2019
©2019 DMC Co., Ltd.

This document can be freely distributed, but any alternation to this document is prohibited



DMC Co., Ltd.

<http://www.dmccoltd.com/english/>

11F Takanawa Sengakuji Ekimae Bldg., 2-18-10 Takanawa, Minato-ku, Tokyo 108-0074, Japan
Phone: +81-3-6721-6731 (Japanese), 6736 (English) Fax: +81-3-6721-673

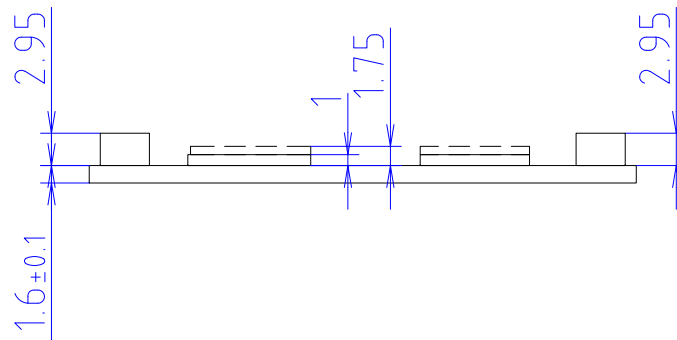
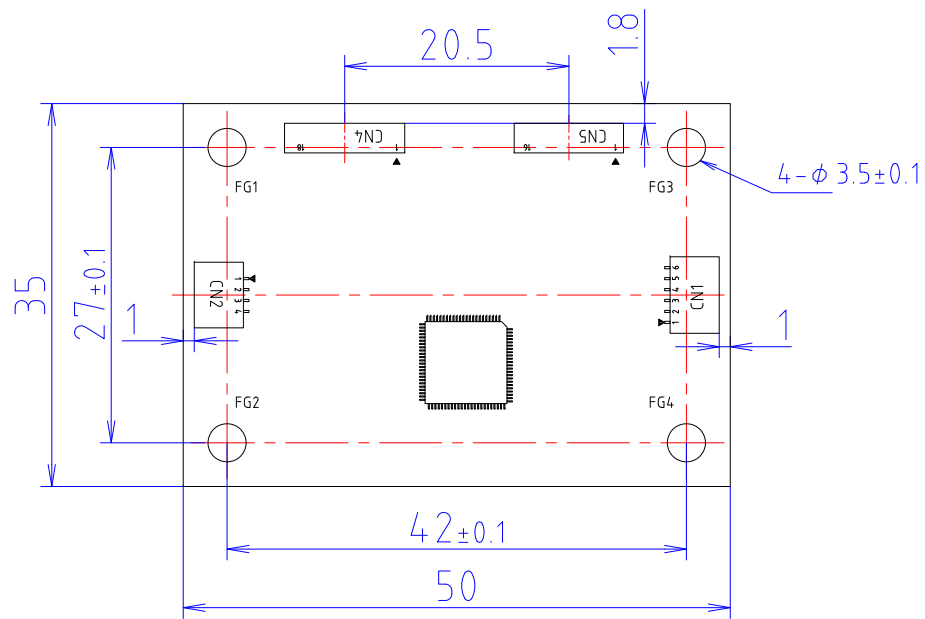

※Tolerance: ±0.3 except for hole diameter
 ※Material: FR-4
 ※Mass: Typ. 7g
 ※Unit: mm

Date	P/N
October 28, 2019	MTR2010
Dimensional Drawing	
DMC Co., Ltd.	
Rev.	1